



# CTR2000

3-phase controller for electric heating,  
230 or 400 V/25 A

CTR2000 is a 3-phase controller intended for time-proportional control of electric heaters, radiators, etc. The controller is capable of controlling both D- and Y-connected loads.

- Automatic adaptation to connected 230 or 400V supply voltage
- PI-control for supply air control and P-control for room control
- Can be controlled with external 0...10V control signal
- For wall mounting

CTR2000 is a 3-phase triac controller for control of electric heaters. The device is connected in series between the power supply and an electric heater or radiator.

CTR2000 has a temperature controller with inputs for sensors placed, for instance, in a supply air duct or room. It can also be controlled using an external control signal.

The controller utilises stepless, time-proportional control. I.e.: the ratio between on-time and off-time is varied in order to fit the present heating requirement.

Example: A controller output of 50 % will equal an on-time of 30 s and an off-time of 30 s if the cycle time is 60 s. The cycle time is adjustable 6...120 s.

Triac control is considerably more accurate than on/off control, meaning increased heating comfort and lowered energy costs.

CTR2000 has a built-in function for automatically adapting the control mode as needed:

### Supply air control

For rapid temperature changes, the supply air controller will function as a PI-controller. The P-band will be 20K with an I-time of 6 minutes.

### Room temperature control

For slower temperature changes, the room controller will function as a P-controller. The P-band will be 1.5K. The supply air controller will retain the same settings as before. During room temperature control, the supply air temperature can be provided with a min. or max. limitation.

- Settable min. and max. limitation
- Adjustable cycle time

### Control of larger loads

In cases where the electric heater is larger than the capacity of CTR2000, the unit can be combined with an ancillary CTR-S1 board (see below). The load can also be divided and controlled by use of a SC4 or SC6 step controller in combination with the CTR2000.

### CTR-S1

The power handling capacity can be increased by an additional 25 A by use of the CTR-S1 relay control board. When used, CTR-S1 will control the electric power output via a contactor. The two part loads must be of equal size, e.g. 25 A max.

For wiring diagram and more information, see instructions for CTR-S1.

### External control signal

CTR2000 can also be run against a 0...10 V DC control signal from another controller. 0 V input signal will give 0 % output and 10 V input will give 100 % output.

Minimum and maximum limit functions are not active when using an external control signal.

## Technical data

Supply voltage	3-phase, 210...255 / 380...415 V AC. Automatic adaptation
Power output	Max. 25 A, min. 3 A/phase. At 400 V, max. effect will be 17 kW
Safety function	The feed to the CTR should be interlocked with a high temp. limit switch
Power emission	45 W at full load
Cycle time	Factory setting 60 sec. Adjustable 6...120 sec
Indicator	Red LED, lit when power is pulsed to heater
Ambient temperature, operation	0...40°C
Ambient humidity	Max 90 %rH
Storage temperature	-40...+50°C
Protection class	IP30



**Low Voltage Directive (LVD) standards:** This product conforms to the requirements of the European Low Voltage Directive (LVD) 2006/95/EC through product standard EN 60730-1.

**EMC emissions & immunity standards:** This product conforms to the requirements of the EMC Directive 2004/108/EC through product standards EN 61000-6-1 and EN 61000-6-3.

**RoHS:** This product conforms with the Directive 2011/65/EU of the European Parliament and of the Council.

## Control unit

Sensor inputs	Main and min./max. sensor. Min./max. sensor: working range 0...60°C
Main setpoint	0...30°C. Other areas dependant on connected sensor. Includes external setpoint (e.g. TG-R430)
Control parameters, primary control	Rapid control circuits: PI-function with a P-band of 20K and I-time of 6 minutes. Slower control circuits: P-function with a P-band of 1.5 K
Setpoint, min. limitation	0...30°C
Setpoint, max. limitation	20...60°C
Control parameters, limitation	PI-function with a P-band of 20K and an I-time of 6 minutes
Output signal, controller	0...10 V. Connected to control input of output unit by wire strap (terminal 7-9)

## Dimensions

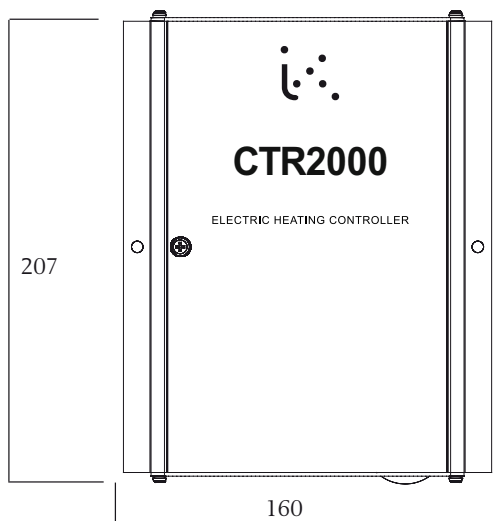

Depth: 94

mm

## Wiring

### Supply voltage

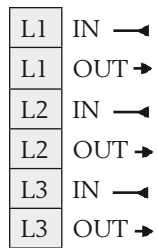

### Room temperature control

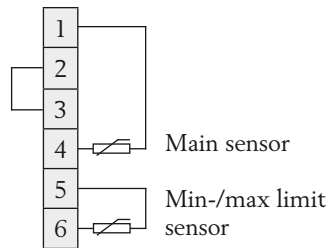

### Room temperature control with external setpoint

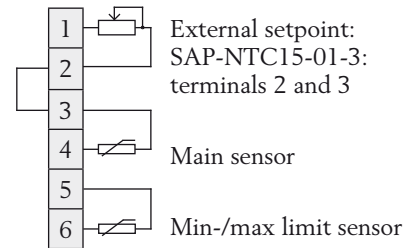

NOTE: When controlling Y-connected loads, the load must be symmetric and the signal neutral must not be connected!

### Constant supply air

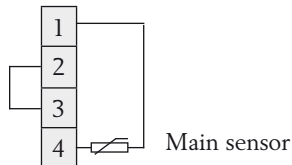

### External signal 0...10 V DC

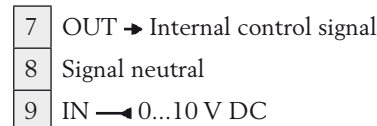

Terminals 7 and 9 are connected by a factory-mounted wire strap. Remove the wire strap when using external control signal.

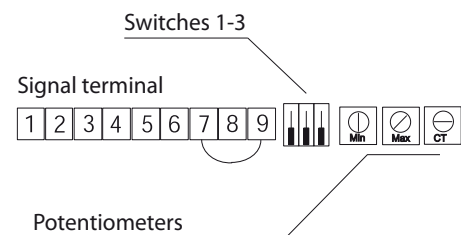
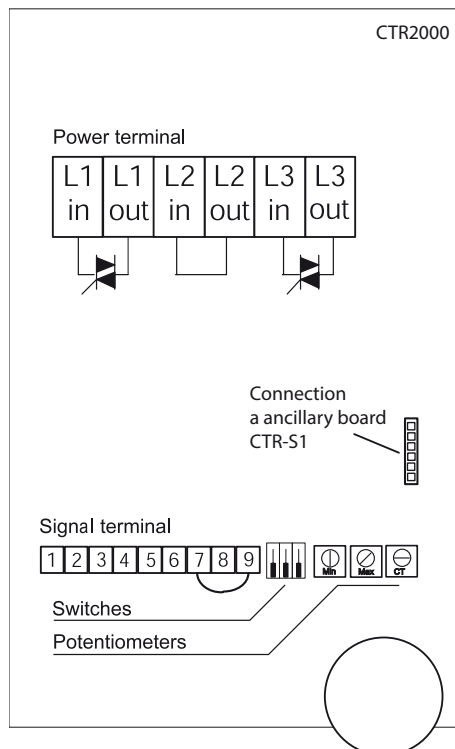

Operating switches:

- 1 - Setpoint:  
Up: Built-in setpoint  
Down: External setpoint
  - 2 - Min. temp. limit.:  
Up: Activated  
Down: Deactivated
  - 3 - Max. temp. limit.:  
Up: Activated  
Down: Deactivated
- Min. and max. limit.  
function can be active  
simultaneously

## Product documentation

Document	Type
Instruction CTR2000	Instruction for CTR2000

The documents can be downloaded from [www.industrietechnik.it](http://www.industrietechnik.it).

### AB Industrietechnik Srl

Via Julius Durst, 70 - 39042 Bressanone (BZ) - Italy  
Tel. +39 0472/830626 - Fax +39 0472/831840  
[www.industrietechnik.it](http://www.industrietechnik.it) - [info@industrietechnik.it](mailto:info@industrietechnik.it)